



97x33 mm

San Ace 97W 9W1BM type 

DC
Splash Proof Blower 97 mm

General Specifications

- Material Frame: Aluminum (Black coating), Plastic (Flammability: UL 94V-0), Impeller: Plastic (Flammability: UL 94V-0)
- Expected life See the table below. (L10 life: 90% survival rate for continuous operation in indoor free air at 60°C, rated voltage)
Expected life at 40°C is for reference only.
- Motor protection function Locked rotor burnout protection, Reverse polarity protection
For details, please refer to p. 599.
- Dielectric strength 50/60 Hz, 500 VAC, for 1 minute (between lead wire conductors and frame)
- Insulation resistance 10 MΩ or more with a 500 VDC megger (between lead wire conductors and frame)
- Sound pressure level (SPL) At 1 m away from the air inlet
- Storage temperature -30 to +70°C (Non-condensing)
- Lead wire ⊕Red ⊖Black (Sensor) Yellow (Control) Brown
- Mass 240 g
- Ingress protection IP68

Specifications

The models listed below **have pulse sensors with PWM control function.**

Model no.	Rated voltage [V]	Operating voltage range [V]	PWM duty cycle [%]	Rated current [A]	Rated input [W]	Rated speed [min ⁻¹]	Max. airflow [m ³ /min] [CFM]	Max. static pressure [Pa] [inchH ₂ O]	SPL [dB (A)]	Operating temperature [°C]	Expected life [h]
9W1BM12P2H001	12	10.2 to 13.8	100	1.3	15.6	4800	1.09 38.5	540 2.17	58	-20 to +70	40000/60°C (70000/40°C)
			20	0.14	1.68	1500	0.32 11.3	51 0.2	30		
9W1BM12P2M001			100	0.9	10.8	4100	0.93 32.8	380 1.53	55		
			20	0.14	1.68	1500	0.32 11.3	51 0.2	30		
9W1BM24P2H001	24	20.4 to 27.6	100	0.65	15.6	4800	1.09 38.5	540 2.17	58		
			20	0.07	1.68	1500	0.32 11.3	51 0.2	30		
9W1BM24P2M001			100	0.45	10.8	4100	0.93 32.8	380 1.53	55		
			20	0.07	1.68	1500	0.32 11.3	51 0.2	30		

* PWM input frequency is 25 kHz; models without specifications at 0% PWM duty cycle have zero fan speed at 0%.

Airflow - Static Pressure Characteristics / PWM Duty - Speed Characteristics Example

9W1BM12P2H001 With pulse sensor with PWM control function

PWM duty cycle

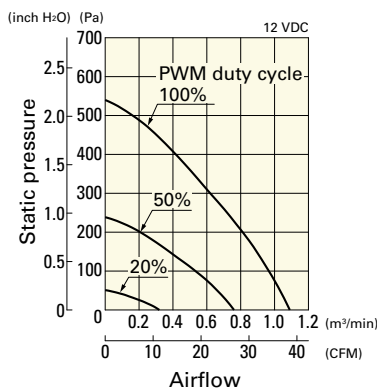

Operating voltage range

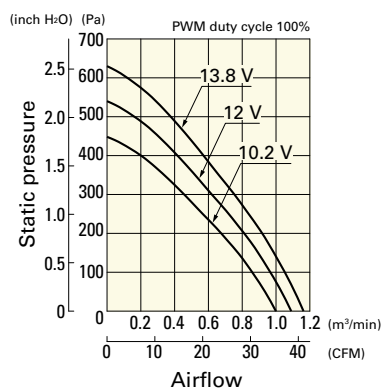

PWM duty - Speed characteristics example

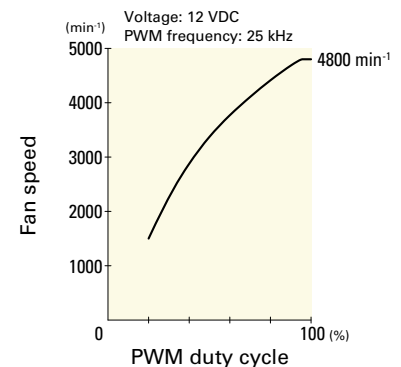

Airflow - Static Pressure Characteristics / PWM Duty - Speed Characteristics Example

9W1BM12P2M001 With pulse sensor with PWM control function

PWM duty cycle

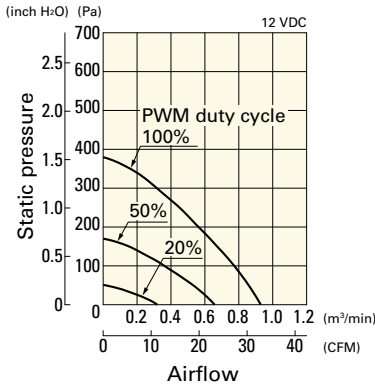

Operating voltage range

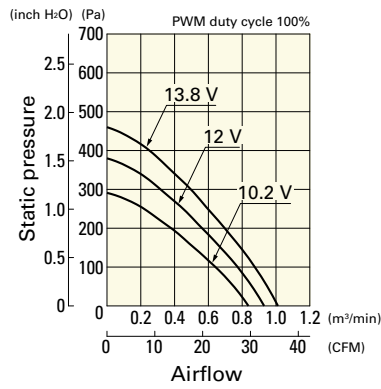

PWM duty - Speed characteristics example

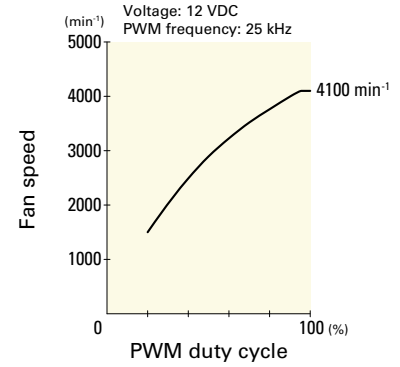

9W1BM24P2H001 With pulse sensor with PWM control function

PWM duty cycle

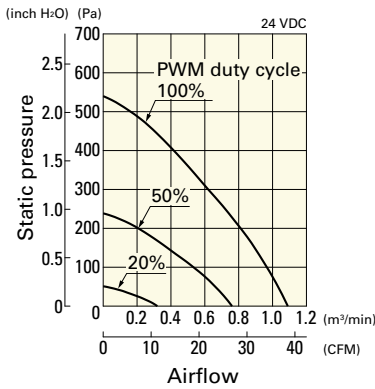

Operating voltage range

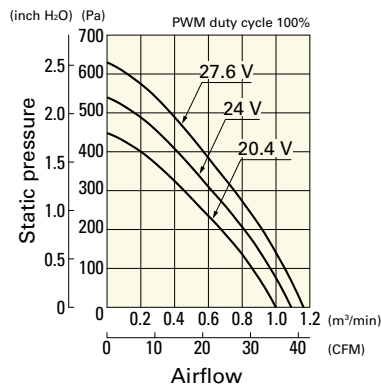

PWM duty - Speed characteristics example

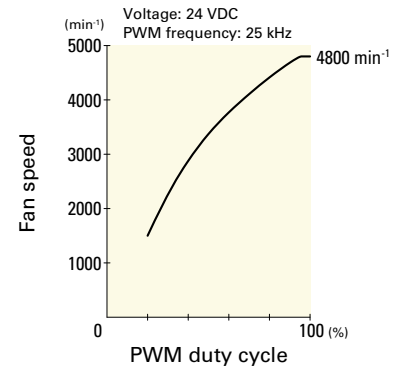

9W1BM24P2M001 With pulse sensor with PWM control function

PWM duty cycle

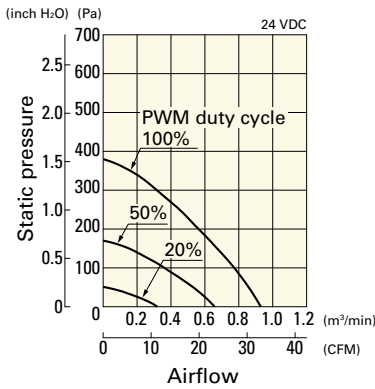

Operating voltage range

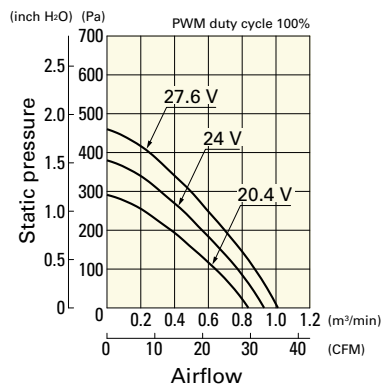

PWM duty - Speed characteristics example

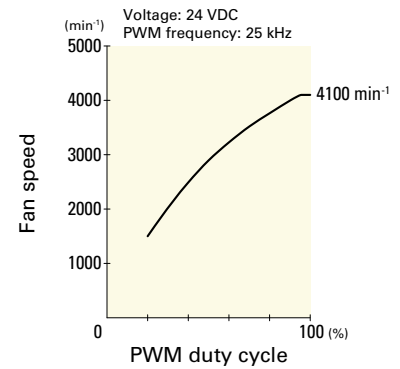

DC

Splash Proof Blower 97 mm

Dimensions (unit: mm)

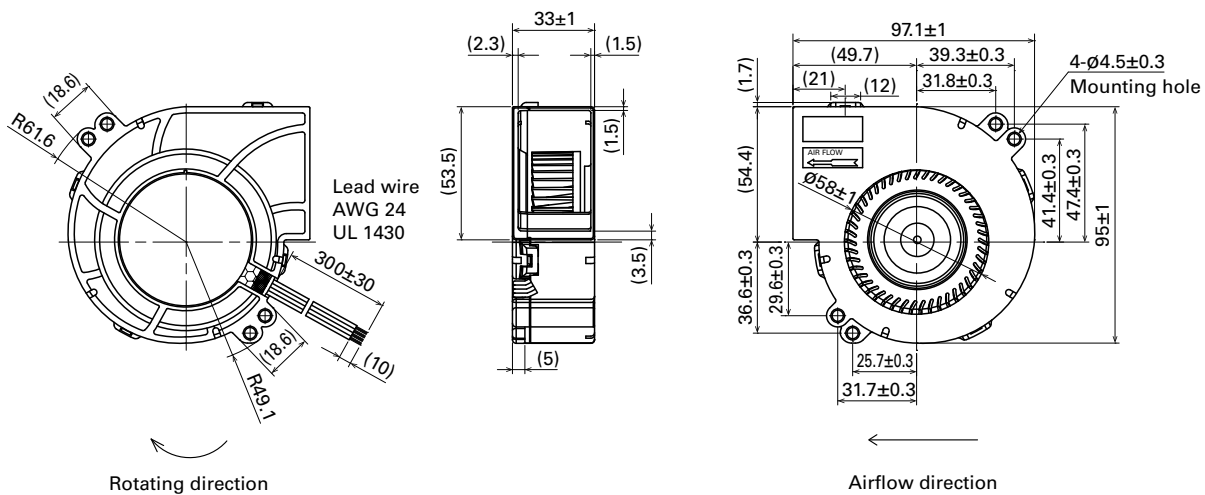

DC
Splash Proof Blower 97 mm