

# 40x40x28 mm

San Ace 40T 9GT type

## General Specifications

- Material ..... Frame: Aluminum, Impeller: Plastic (Flammability: UL 94V-1)
- Expected life ..... See the table below. (L10 life: 90% survival rate for continuous operation in free air at 60°C, rated voltage)
- Motor protection function ..... Locked rotor burnout protection, Reverse polarity protection  
For details, please refer to p. 529.
- Dielectric strength ..... 50/60 Hz, 500 VAC, for 1 minute (between lead wire conductors and frame)
- Insulation resistance ..... 10 MΩ or more with a 500 VDC megger (between lead wire conductors and frame)
- Sound pressure level (SPL) ..... At 1 m away from the air inlet
- Storage temperature ..... -40 to +85°C (Non-condensing)
- Lead wire ..... ⊕Red ⊖Black (Sensor) Yellow (Control) Brown
- Mass ..... 55 g

## Specifications

The models listed below **have pulse sensors with PWM control function.**

Model no.	Rated voltage [V]	Operating voltage range [V]	PWM duty cycle* [%]	Rated current [A]	Rated input [W]	Rated speed [min <sup>-1</sup> ]	Max. airflow [m <sup>3</sup> /min] [CFM]	Max. static pressure [Pa] [inchH <sub>2</sub> O]	SPL [dB (A)]	Operating temperature [°C]	Expected life [h]
9GT0412P3J001	12	10.2 to 13.8	100	0.31	3.72	11700	0.52 18.4	206 0.827	48	-40 to +85	40000/85°C
			30	0.08	0.96	4100	0.18 6.36	25.2 0.1	21		
9GT0424P3J001	24	20.4 to 27.6	100	0.15	3.6	11700	0.52 18.4	206 0.827	48	-40 to +85	40000/85°C
			30	0.05	1.2	4100	0.18 6.36	25.2 0.1	21		

\* PWM frequency: 25 kHz. Fan does not rotate when PWM duty cycle is 0%.

Other sensor specifications are available as options. Refer to the index (p. 554).

## Airflow - Static Pressure Characteristics / PWM Duty - Speed Characteristics Example

**9GT0412P3J001** With pulse sensor with PWM control function

PWM duty cycle

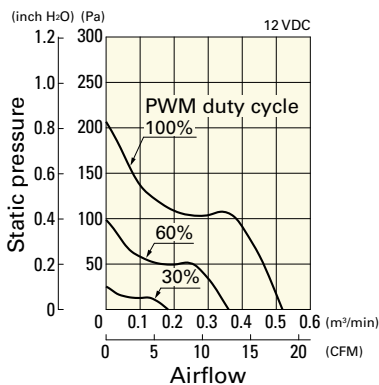

Operating voltage range

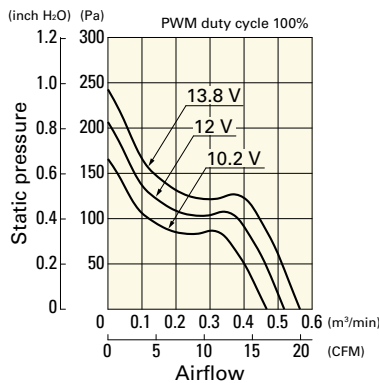

PWM duty - Speed characteristics example

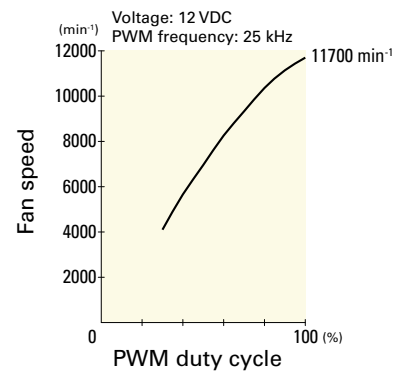

## Airflow - Static Pressure Characteristics / PWM Duty - Speed Characteristics Example

9GT0424P3J001 With pulse sensor with PWM control function

PWM duty cycle

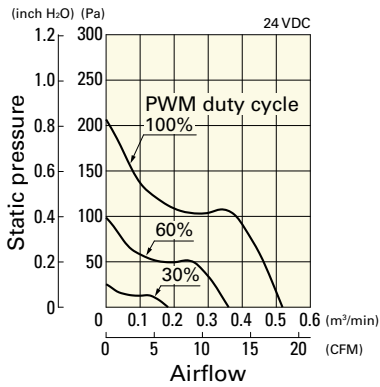

Operating voltage range

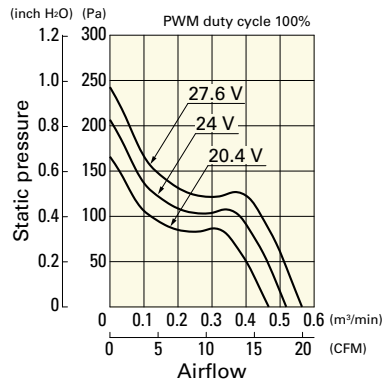

PWM duty - Speed characteristics example

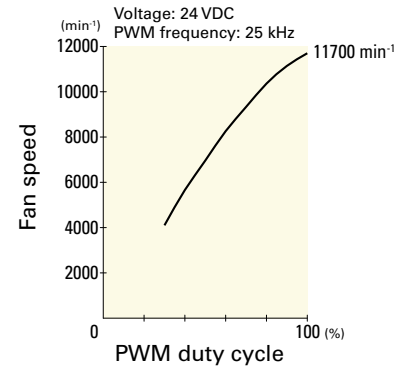

## Dimensions (unit: mm)

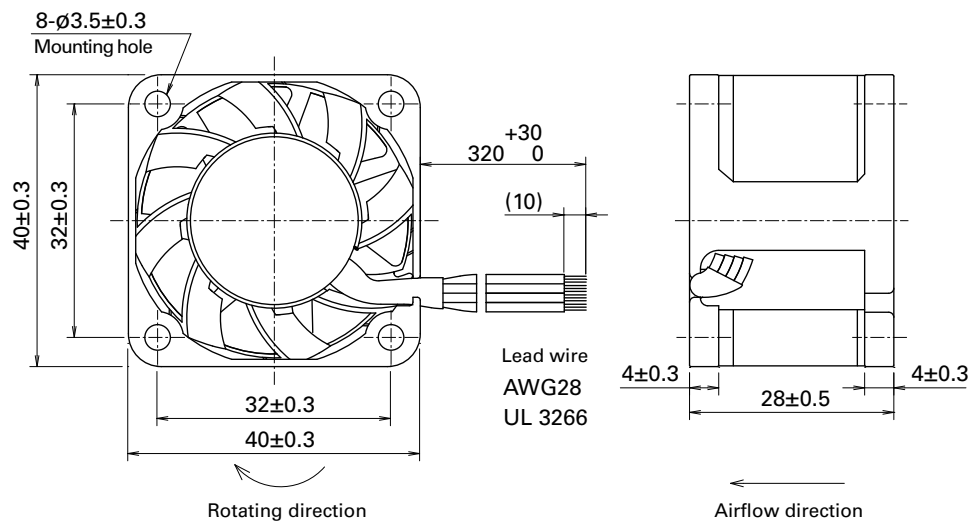

## Reference Dimensions of Mounting Holes and Vent Opening (unit: mm)

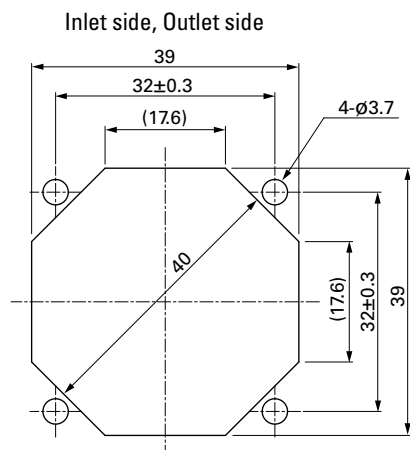

## Options

Finger guards

page: p. 513

Model no.: 109-059, 109-059H

DC  
Wide Temperature Range Fan 40 mm sq.