

San Ace 225W 9W2T type

Splash Proof Centrifugal Fan

Features

High Airflow

Maximum airflow achieves 23.5 m³/min.

Water and Dust Resistant

This fan has an IP56 rated water and dust proof performance.* It ensures stable operation of the fans even in harsh environments.

Low Noise and High Energy Efficiency

The PWM control function enables the external control of fan speed, contributing to lower noise and higher energy efficiency of devices.

* Ingress Protection (IP Code) rating is defined by International Electrotechnical Commission (IEC).
IP56 rating:
- Protection against a level of dust that could hinder operation or impair safety
- Protection against high pressure water jets



∅225×99 mm

Specifications

The following nos. **have PWM controls, pulse sensors.**

Model no.	Rated voltage [V]	Operating voltage range [V]	PWM duty cycle* [%]	Rated current [A]	Rated input [W]	Rated speed [min ⁻¹]	Max. airflow [m ³ /min] [CFM]	Max. static pressure [Pa] [inchH ₂ O]	SPL [dB(A)]	Operating temperature [°C]	Expected life [h]
9W2TS48P0S001	48	36 to 72	100	2.45	117.6	3000	23.5 830	635 2.55	72.0	-25 to +70	40000/60°C (70000/40°C)
			15	0.24	11.5	1000	7.83 276	70.6 0.28	52.5		

* PWM frequency: 25 kHz. Fan does not rotate when PWM duty cycle is 0%.

When inlet nozzle [Option (Model: 109-1134H)] is mounted.

Max input is 220 W at rated voltage.

Common Specifications

- Material Motor case: Aluminum (Black coating), Impeller: Plastics (Flammability: UL 94V-0)
- Expected life Refer to specifications
(Indoor, L10: Survival rate: 90% at 60°C, rated voltage, and continuously run in a free air state)
Expected life at 40°C ambient is just reference value.
- Motor protection system Current blocking function and reverse polarity protection
- Dielectric strength 50/60 Hz, 500 VAC, 1 minute (between lead conductor and motor case)
- Sound pressure level (SPL) Expressed as the value at 1 m from air inlet side
- Operating temperature Refer to specifications (Non-condensing)
- Storage temperature -30 to +70°C (Non-condensing)
- Lead wire ⊕Red ⊖Black Sensor: Yellow Control: Brown
- Mass Approx. 1500 g

Airflow - Static Pressure Characteristics

- PWM duty cycle

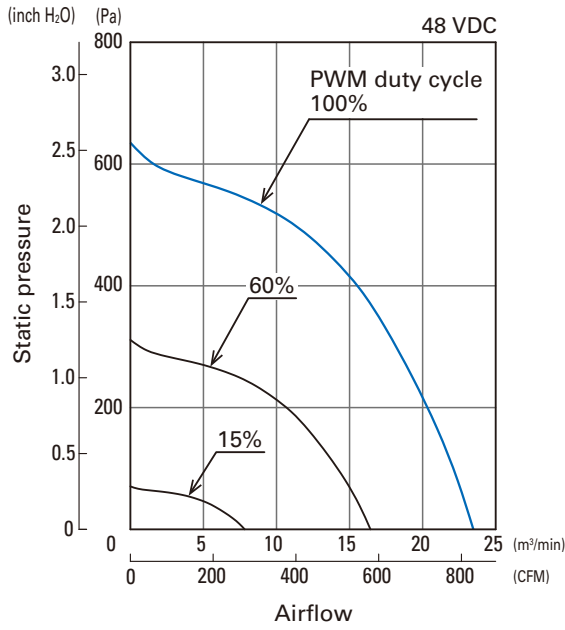

- Operating voltage range

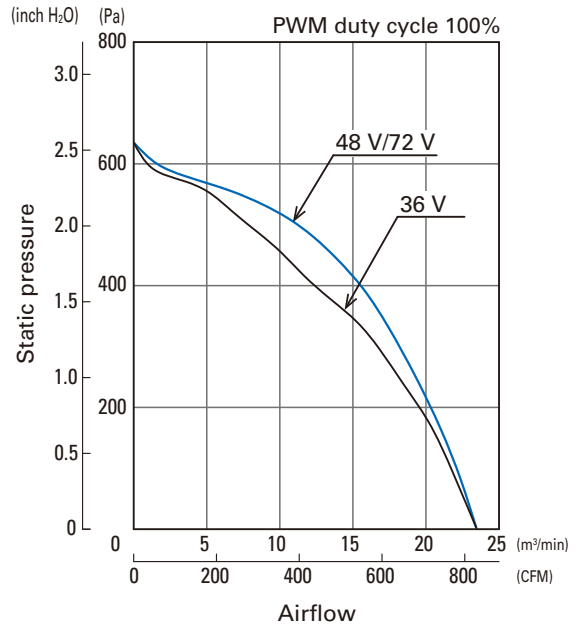

PWM Duty - Speed Characteristics Example

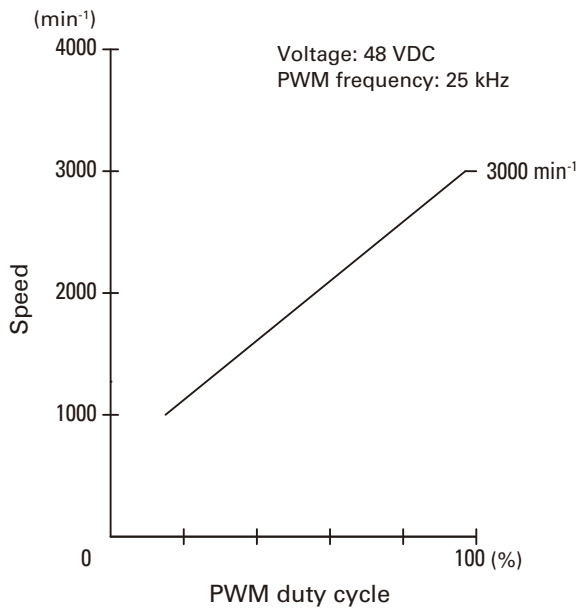

PWM Input Signal Example

Input signal waveform

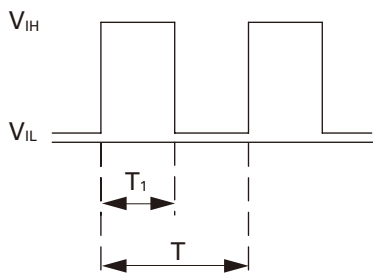

$V_{IH} = 4.75 \text{ to } 5.25 \text{ V}$ $V_{IL} = 0 \text{ to } 0.4 \text{ V}$
 PWM duty cycle (%) = $\frac{T_1}{T} \times 100$ PWM frequency 25 (kHz) = $\frac{1}{T}$
 Current source (I_{source}) = 1 mA max. (when control voltage is 0 V)
 Current sink (I_{sink}) = 1 mA max. (when control voltage is 5.25 V)
 Control terminal voltage = 5.25 V max. (when control terminal is open)

When the control terminal is open,
 fan speed is the same as when PWM duty cycle is 100%.
 Either TTL input, open collector or open drain can be used for
 PWM control input signal.

Example of Connection Schematic

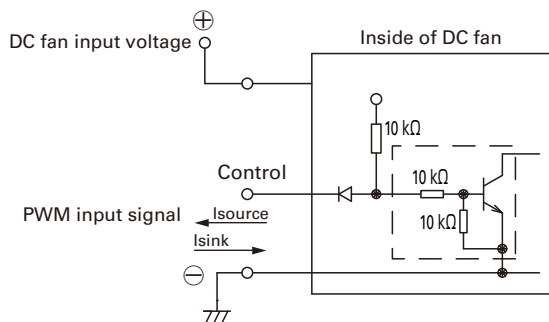

Specifications for Pulse Sensors

Output circuit: Open collector

Inside of DC fan

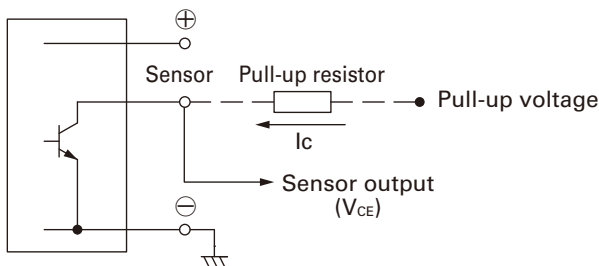

$V_{CE} = +72 \text{ V max.}$
 $I_c = 10 \text{ mA max. [} V_{OL} = V_{CE} \text{ (SAT)} = 1 \text{ V max.]}$

Output waveform (Need pull-up resistor)

In case of steady running

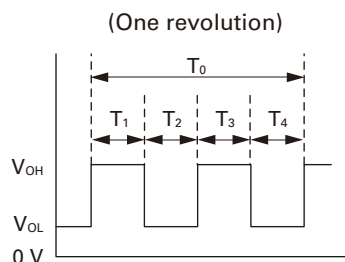

$T_{1 \text{ to } 4} \doteq (1/4) T_0$
 $T_{1 \text{ to } 4} \doteq (1/4) T_0 = 60/4N \text{ (s)}$
 $N = \text{Fan speed (min}^{-1}\text{)}$

