

40×40×28 mm High Static Pressure Fan *San Ace 40 9HVA Type*

Hikaru Urushimoto Katsumichi Ishihara Atsushi Yanagisawa

Shuji Miyazawa Toshiyuki Nakamura Hiromitsu Kuribayashi

1. Introduction

In the 1U server and ICT equipment market, there is increasing demand for high-performance compact cooling fans capable of supporting equipment with enhanced functionality and denser component mounting conditions. Furthermore, in recent years, many customers have emphasized the need to reduce power consumption. To do this, it is important to achieve high static pressure and energy savings.

To meet these requirements, we have developed and released the *San Ace 40 9HVA* type High Static Pressure Fan (hereinafter, “new model”) which features a newly designed impeller, frame, motor, and circuit.

This article will introduce some of the features and performance of the new model.

High performance has been achieved while maintaining the size of the current model.



Fig. 1 40 × 40 × 28 mm *San Ace 40 9HVA* type

2. Product Features

Figure 1 shows the appearance of the new model.

The features of the new model are:

- (1) High static pressure
- (2) Low power consumption

3. Product Outline

3.1 Dimensions

Figure 2 shows the dimensions of the new model. The fan’s external dimensions and mounting hole dimensions are unchanged and compatible with our current model.

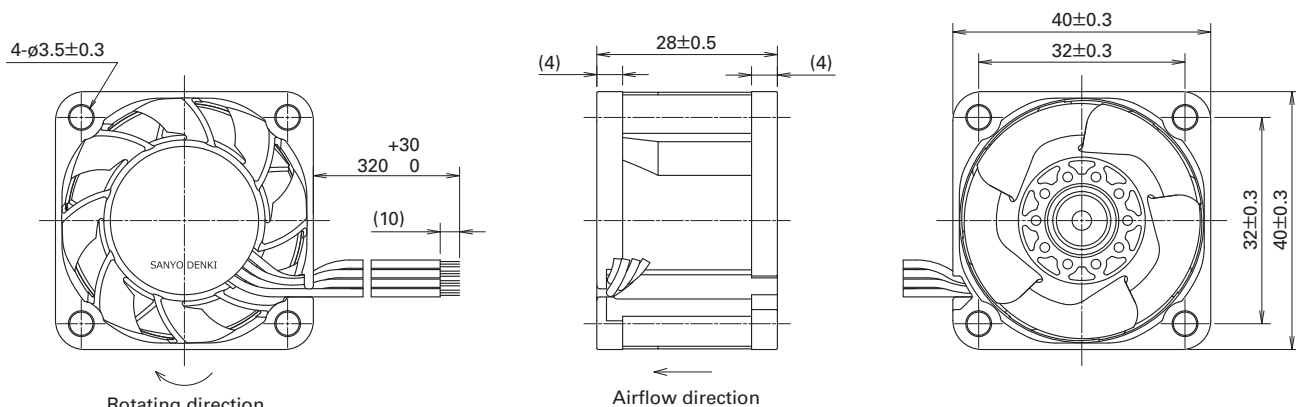

Fig. 2 Dimensions of the new model (Unit: mm)

3.2 Specifications

3.2.1 General specifications

Table 1 shows the general specifications for the new model. The rated voltage is 12 VDC and the rated speed is 38,000 min⁻¹ (J speed), making it suitable for the 1U server market.

Table 1 General specifications for the new model

Model no.	Rated voltage [V]	Operating voltage range [V]	PWM duty cycle* [%]	Rated current [A]	Rated input [W]	Rated speed [min ⁻¹]	Max. airflow		Max. static pressure		SPL [dB(A)]	Operating temperature range [°C]	Expected service life [h]
							[m ³ /min]	[CFM]	[Pa]	[inchH ₂ O]			
9HVA0412P3J001	12	10.2 to 13.8	100	2.60	31	38000	1.05	37.1	2300	9.24	71	-20 to +70	30000 at 60°C (53000 at 40°C)
			20	0.12	1.4	8000	0.22	7.8	101	0.41	34		

* Input PWM frequency: 25 kHz; speed is 0 min⁻¹ at 0% PWM duty cycle.

Note: The expected life at an ambient temperature of 40°C is for reference purpose only.

3.2.2 Airflow vs. static pressure characteristics

Figure 3 shows the airflow vs. static pressure characteristics for the new model. It shows the characteristics at 100% and 20% PWM duty cycles at a rated voltage of 12 V.

3.2.3 PWM control function

The new model has a PWM control function that enables external control of fan speed.

See Figure 3 for the airflow vs. static pressure characteristics at different PWM duty cycles.

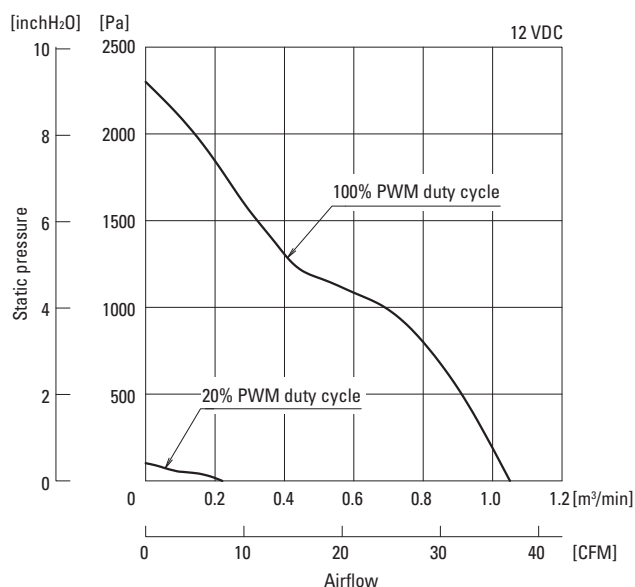

Fig. 3 Airflow vs. static pressure characteristics of the new model

3.3 Expected life

The new model has an expected life of 30,000 hours at 60°C (survival rate of 90%, run continuously at rated voltage and normal humidity in free air).

4. Key Points of Development

The new model achieves a significant improvement in static pressure compared to our current 40 × 40 mm fans. To achieve the target static pressure performance, it was necessary to increase the speed of the motor, while also optimizing the shape of the impeller and frame.

The impeller, frame, motor, and circuit were all newly designed to achieve these goals.

In the following sections, we will describe the main features of the new model as well as the differences between it and the *San Ace 40 9HV* type (hereinafter, “current model”).

4.1 Impeller and frame design

To achieve a significantly higher static pressure performance than the current model, the fan speed of the new model had to be increased to 38,000 min⁻¹, while also optimizing the shape of the impeller and frame. Since this is the fastest speed among all of our fans, we designed the impeller to withstand it.

In addition, the current model used aluminum as the frame material, but the new model uses resin to reduce weight. Resin has lower heat dissipation performance than aluminum, and this makes cooling down the motor more difficult. However, we improved its cooling performance by adjusting the number and size of the impeller’s vent holes.

Figure 4 shows an impeller shape comparison for the current model and new model.

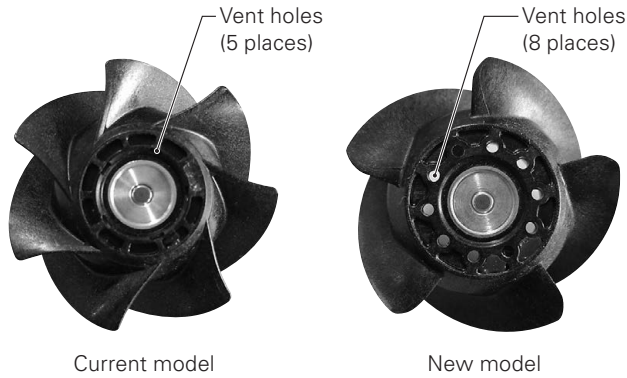

Fig. 4 Impeller shape comparison between current and new models

4.2 Motor and circuit design

Figure 5 shows the motors of the current model and new model. To achieve a higher fan speed, it was necessary to develop a circuit that would provide current to the motor through high-frequency switching, while also reducing motor vibration. To accomplish these, we designed a new circuit and motor; the new circuit suppresses peak current values even at high switching speeds and the new 3-phase motor provides low cogging torque and vibration.

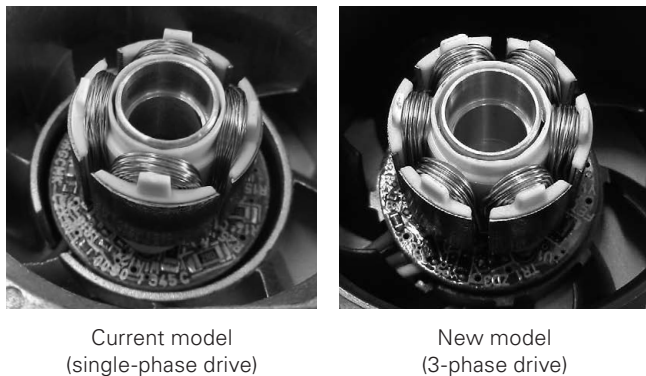

Fig. 5 Motors of the current and new models

The higher speed has increased power consumption to 31 W. As a result, the new model consumes the most power among all of our 40 × 40 mm fans. This 1.7 times higher power consumption than the current model raised an issue of heat generated by electronic components. If a larger fan size could be used, the size of the PCB could also be enlarged. This would enable the use of large components with high current-carrying capacities or the use of multiple electronic components to facilitate heat dissipation. However, 40 × 40 mm fans do not support larger PCBs because the larger board size would reduce the ventilation area and degrade aerodynamic performance. It was against this backdrop that we decided to optimize the component layout so as to maximize the internal cooling effect of the

impeller's ventilation holes, as mentioned above. As a result, we achieved a high-speed fan circuit design that uses the same PCB size as the current model.

5. Comparison with Current Model

5.1 Comparison of airflow vs. static pressure characteristics

Figure 6 compares the airflow vs. static pressure characteristics of the new model and the current model. Airflow and static pressure have been improved 1.26 times and 2.1 times that of the current model, respectively. According to the estimated system impedance curves in the figure, the new model's operating airflow is 28% higher than the current model when used in a device with low system impedance. Furthermore, its operating airflow is 33% higher than the current model when used in a device with high system impedance.

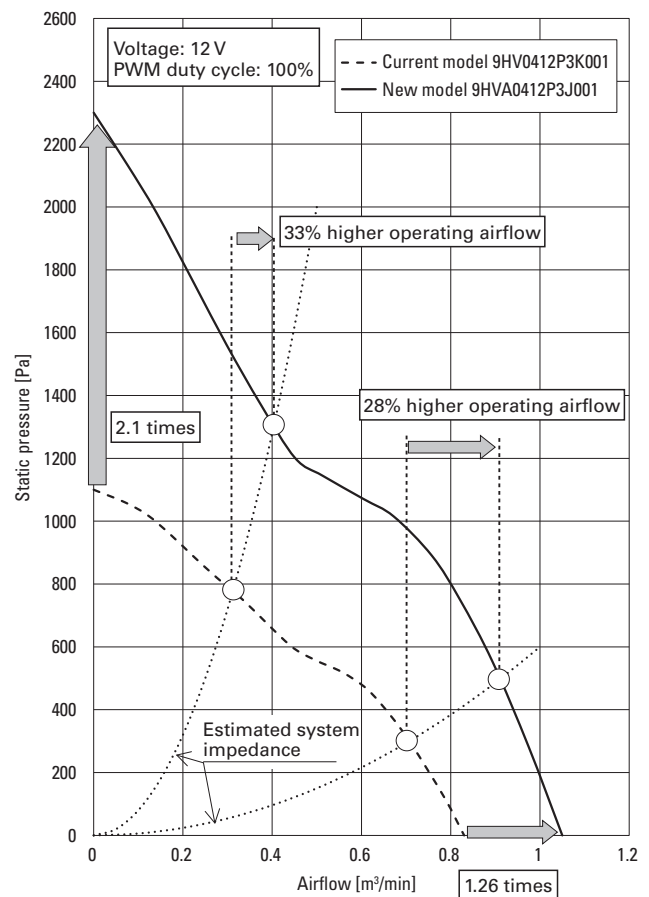

Fig. 6 Airflow vs. static pressure characteristics of the new and current models

5.2 Comparison of power consumption at an equivalent performance level as the current model

Figure 7 provides a comparison of power consumption for the current and new models at equivalent cooling performance. When the fan speed of the new model is reduced with PWM control to obtain the same cooling performance as that of the current model, power consumption is lower across all operating ranges. In particular, it is 20% lower near the maximum airflow and 10% lower in the high static pressure range. This reduces running costs for the new model.

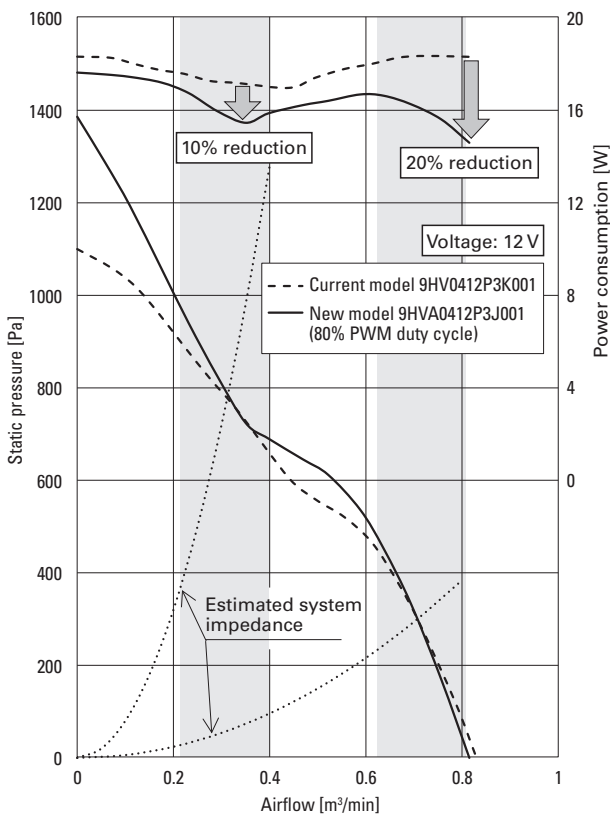

Fig. 7 Airflow vs. static pressure characteristics (Compared with the current model)

5.3 Comparison with a 40 × 40 × 56 mm product

The cooling performance of the new model even exceeds that of a 40 × 40 × 56 mm Counter Rotating Fan, whose thickness is twice that of the new model.

Figure 8 provides a comparison of the airflow vs. static pressure characteristics with a 40 × 40 × 56 mm 9CRV0412P5J201 Counter Rotating Fan.

The maximum static pressure of the new model is 2.2 times higher than that of the even thicker Counter Rotating Fan, and its cooling performance is greater across all operating ranges. As a result, the new model will be effective in space saving.

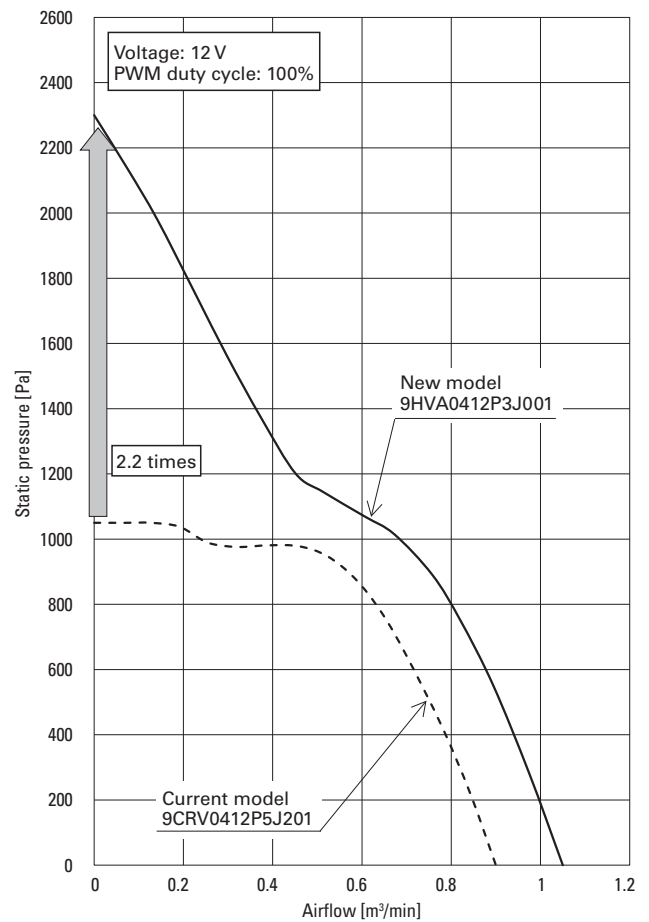

Fig. 8 Airflow vs. static pressure characteristics (Compared with a 40 × 40 × 56 mm Counter Rotating Fan)

6. Conclusion

In this article, we introduced some of the features and performance of the 40 × 40 × 28 mm *San Ace 40 9HVA* type High Static Pressure Fan.

Compared to our current model, the new model offers significantly higher static pressure. Furthermore, when cooling performance is equivalent to that of the current model, the new model greatly reduces power consumption.

We expect that the high static pressure and low power consumption features of the new model will make a significant contribution to the market by facilitating energy savings and cooling in high-density devices.

We plan to continue developing cooling fans that make use of the most advanced technologies so that we can quickly adapt to customer needs.

Author

Hikaru Urushimoto

Cooling Systems Div., Design Dept.

Works on the development and design of cooling fans.

Katsumichi Ishihara

Cooling Systems Div., Design Dept.

Works on the development and design of cooling fans.

Atsushi Yanagisawa

Cooling Systems Div., Design Dept.

Works on the development and design of cooling fans.

Shuji Miyazawa

Cooling Systems Div., Design Dept.

Works on the development and design of cooling fans.

Toshiyuki Nakamura

Cooling Systems Div., Design Dept.

Works on the development and design of cooling fans.

Hiromitsu Kuribayashi

Cooling Systems Div., Design Dept.

Works on the development and design of cooling fans.