

Development of the *SANMOTION F* Series 42 mm sq. 2-Phase 1.8° Stepping Motor

Koji Nakatake Yasushi Yoda Mitsuaki Shioiri Hong Zhang

Kazuhiro Yoda Shogo Yoda Akio Miyahara

1. Introduction

As stepping motors are capable of performing high-accuracy positioning control in a simple system, they are used in a broad range of applications and fields, including OA devices, general industrial devices, and semiconductor manufacturing equipment. SANYO DENKI has focused product development on higher functionality and customization and has expanded the application scope of stepping motors for general industrial devices to the extent replacement of AC servo motors is possible.

Meanwhile, there is a growing demand for 2-phase stepping motors in applications where stepping motors have traditionally been used; namely, money-handling equipment such as automatic teller machines, biochemical analysis equipment, and medical devices such as artificial dialysis machines. The features required in these markets are low torque, low noise, and eco-efficiency. Also, emphasis is placed on compatibility with current models.

To satisfy these market requirements, SANYO DENKI developed the *SANMOTION F* 42 mm sq. 2-Phase 1.8° stepping motor. This article describes the new model's specifications and features, as well as the technologies behind them.

2. Specifications of the New Model

2.1 External view

Figure 1 shows an external view of the new model. The connector type of the new model is common to the entire series, and is designed to be inserted from the top of the stepping motor. Compared to the current model, where the connector is inserted from the direction of the output axis, the new design makes it easier to route the lead wire. Moreover, there is no need to secure space for looping back the lead wire cabling, which allows the customer greater freedom when designing equipment. Lead wire customization is done via the conventional method of using a terminal harness.

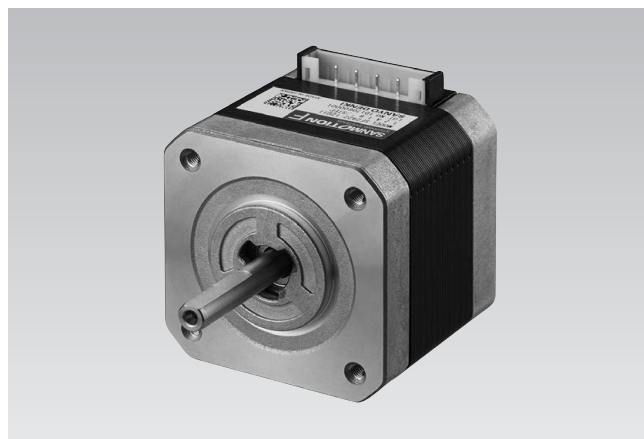

Fig. 1: External view of the new model (SF2422 type)

2.2 External dimensions

Figure 2 shows the new model's main external specifications. The flange size is 42 mm sq., with the same mounting pitch and mounting pilot dimensions as the current model. This means there is mounting compatibility between the new and current models, which makes for easy replacement. As with the current model, shaft specifications can be customized.

2.3 Lineup and main specifications

Table 1 and Table 2 show the lineup and main specifications for unipolar and bipolar type stepping motors, respectively. SANYO DENKI has prepared a total of 16 standard models to choose from, including the four different motor lengths of 33 mm, 39 mm, 48 mm and 59.5 mm, unipolar models and bipolar models with differing torques, and single shaft and double shaft models. As the new models are the same length as the current model, replacement is possible without the need for customers to change their equipment specifications.

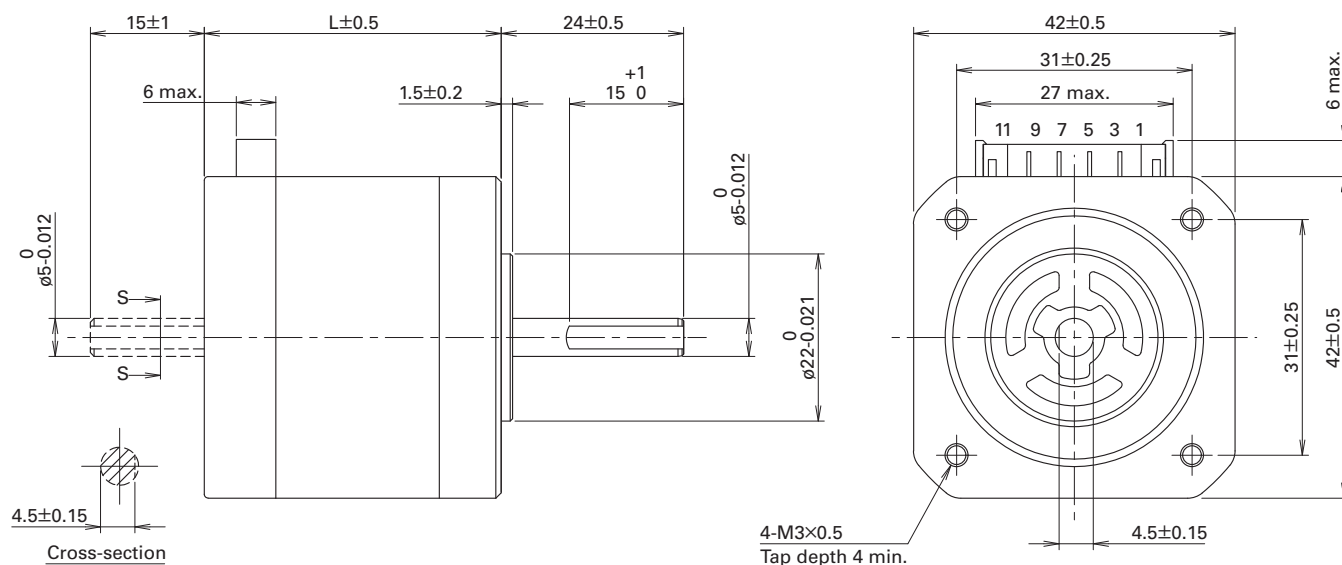

Fig. 2: External dimensions of the new model

Table 1: Lineup and main specifications for the unipolar type

Model no.		Holding torque at 2-phase excitation [N · m] MIN.	Rated current [A/phase]	Winding inductance [mH/phase]	Rotor inertia [$\times 10^{-4}$ kg · m ²]	Mass [kg]	Motor length L [mm]
Single shaft	Double shaft						
SF2421-12U41	SF2421-12U11	0.22	1.2	2.4	0.031	0.23	33
SF2422-12U41	SF2422-12U11	0.33	1.2	3.3	0.046	0.3	39
SF2423-12U41	SF2423-12U11	0.4	1.2	3.9	0.063	0.38	48
SF2424-12U41	SF2424-12U11	0.58	1.2	5.4	0.094	0.51	59.5

Table 2: Lineup and main specifications for the bipolar type

Model no.		Holding torque at 2-phase excitation [N · m] MIN.	Rated current [A/phase]	Winding inductance [mH/phase]	Rotor inertia [$\times 10^{-4}$ kg · m ²]	Mass [kg]	Motor length L [mm]
Single shaft	Double shaft						
SF2421-10B41	SF2421-10B11	0.29	1	7	0.031	0.23	33
SF2422-10B41	SF2422-10B11	0.43	1	9.6	0.046	0.3	39
SF2423-10B41	SF2423-10B11	0.56	1	12.5	0.063	0.38	48
SF2424-10B41	SF2424-10B11	0.8	1	16	0.094	0.51	59.5

3. Product Features

3.1 High torque

Figure 3 shows a comparison of pull-out torque characteristics. The new model has 10 to 15% higher torque than the current model. To achieve this higher torque, we incorporated the following innovative ideas.

(1) Optimal stator core magnetic circuit design

Figure 4 is a schematic of the stator core profile. The stator core is comprised of a back yoke and poles, which act as magnetic circuits, and the teeth at the tip of the poles. We optimized the stator core magnetic circuit by systematically analyzing the shapes of the above-mentioned components and using magnetic circuit simulation. This has not only

increased torque, but also reduced iron loss.

(2) Larger winding space

By identifying the areas where magnetic flux density easily became saturated, and adjusting the widths of the back yoke and poles to prevent magnetic flux from concentrating, we widened the winding space to the greatest extent possible. This has the effect of minimizing the increase in copper loss without reducing torque.

(3) Adoption of a magnet with high residual magnetic flux density

By adopting a magnet with high residual magnetic flux density, higher torque has been achieved without increasing the overall motor length.

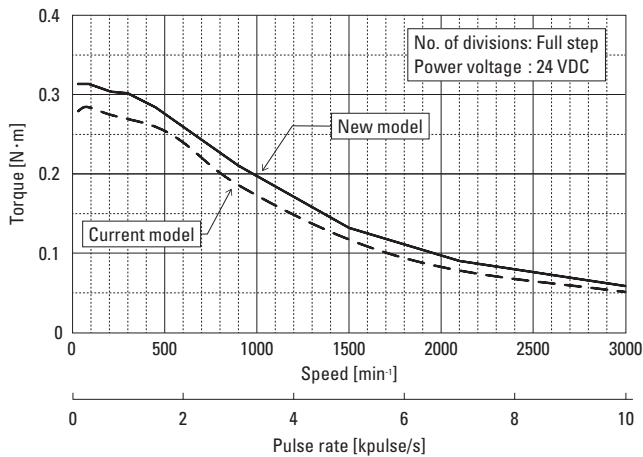

Fig. 3: Pull-out Torque characteristics comparison (SF2422-12U41)

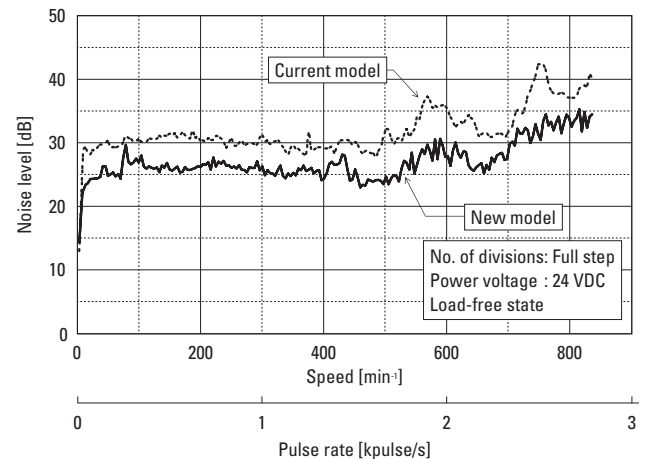

Fig. 5: Noise characteristic comparison (SF2422-12U41)

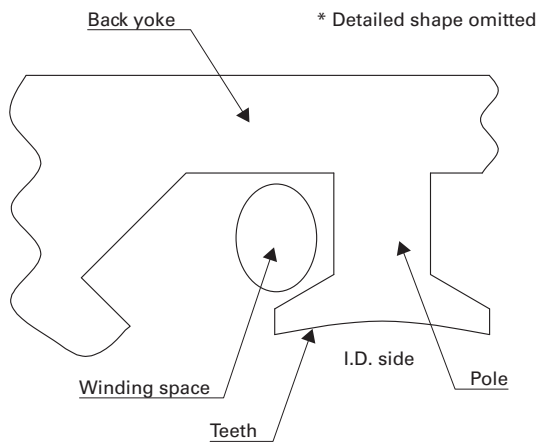

Fig. 4: Stator core profile schematic

3.2 Low noise

Figure 5 shows a noise characteristic comparison. Compared with the current model, the noise level of the new model in its operating range has been reduced by between 3 and 5 dB. Medical devices in which stepping motors are used are often operated in close proximity to patients, therefore minimal noise is preferable. To achieve low noise, we incorporated the following innovative ideas.

(1) High-rigidity stator core

We analyzed the structure of the back yoke and poles and obtained the dimensions that would increase both rigidity and torque, which resulted in higher stator core rigidity.

(2) High-rigidity motor

We revised the tightening allowance between the stator and the flange/end cap as well as the engagement length to increase post-assembly motor rigidity and, ultimately, reduce noise.

3.3 Higher eco-efficiency through increased motor efficiency

Compared to the current model, the new model has 2% higher efficiency. We reduced iron loss through the above-mentioned optimization of the stator core design. Furthermore, copper loss was reduced by expanding the winding space. The reduction of these losses made it possible to achieve equivalent torque to the current model with less input current, therefore, taking SF2422-12U41 as an example, the following is achieved.

- 10°C or higher reduction in motor temperature increase
- 10% reduction in input current

This results in low heat generation and better eco-efficiency of equipment, the former point making it a safer motor to use particularly in medical devices that operate in close proximity to patients.

3.4 Motor structure design suitable for automatic production line

An automatic production line was adopted for the new model to eliminate variations caused by manual work and improve both quality and productivity. From the initial development phase, we designed the motor structure to suit automatic production and devised creative ways to eliminate processes that had conventionally been performed manually. For the current model, the wiring and connection processes are performed separately, with the latter in particular being performed by hand. In the new model a pin is set in the insulator, and by tying the beginning and the end of the winding it is possible to simultaneously perform both winding and connection automatically in a winding machine. By adopting this structure, we have secured pin strength and winding nozzle space, as well as established a structure for easily connecting the winding to the pin.

Moreover, the new product was designed so it could easily be manufactured automatically through measures such as using a rotor with the least possible amount of machining cost, and enabling easy determination of orientation and direction by establishing assembly standards for each component, etc.

These structural design components make the new model well-suited to an automatic production line, thereby achieving improved quality and productivity, as well as a constant stable supply of high-quality products.

4. Conclusion

This paper has introduced the specifications and features of the *SANMOTION F* series 42 mm sq. 2-Phase 1.8° stepping motor.

The new model improves upon those characteristics required in applications where stepping motors are increasingly being demanded, such as money-handling equipment and medical devices. The new model can easily replace the current model because of mounting and size compatibility. Moreover, SANYO DENKI has established an optimal structural design for automatic production and product specifications which improve productivity. Through this development, we are able to offer our customers greater safety and peace of mind, as a stable supply of a high-quality product is ensured. This stepping motor can be proposed both as a new product in a broad market or as a replacement to update older models at the same time as offering optimal specifications for money-handling equipment and medical devices.

SANYO DENKI intends to apply the technologies used for this development to stepping motors other than the 42 mm sq. size, and prepare a lineup that satisfies the ever-changing and diverse needs of the market to offer products that create new value for our customers.

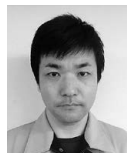

Koji Nakatake

Joined SANYO DENKI in 2001.
Servo Systems Div., Design Dept. 1
Works on the development and design of stepping motors.

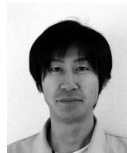

Yasushi Yoda

Joined SANYO DENKI in 2002.
Servo Systems Div., Design Dept. 1
Works on the development and design of stepping motors.



Mitsuaki Shioiri

Joined SANYO DENKI in 1999.
Servo Systems Div., Design Dept. 1
Works on the development and design of stepping motors.

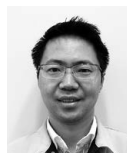

Hong Zhang

Joined SANYO DENKI in 2007.
Servo Systems Division
Application Engineering Dept.
Works on the design and technical proposals of servo systems.



Kazuhiro Yoda

Joined SANYO DENKI in 2008.
Servo Systems Div., Design Dept. 1
Works on the development and design of stepping motors.



Shogo Yoda

Joined SANYO DENKI in 2009.
Servo Systems Div., Design Dept. 1
Works on the development and design of stepping motors.



Akio Miyahara

Joined SANYO DENKI in 1991.
Servo Systems Div., Design Dept. 1
Works on the development and design of servo motors and stepping motors.