

# Splash Proof Blower *San Ace 97W 9W1B Type*

Koji Ono      Toshiya Nishizawa      Kakuhiko Hata

Takahisa Toda      Masaki Kodama      Hiromitsu Kuribayashi

## 1. Introduction

Devices today, including battery packs, ventilation systems, commercial kitchen equipment, and digital signage, are becoming denser. Cooling of such equipment is performed at a high static pressure range which cannot be covered using axial flow fans, so demand for blowers has grown. Moreover, these types of equipment are often used outdoors, exposed to water, or close to people, so are also required to have high waterproof performance and low sound pressure level (hereinafter “SPL”).

To meet these requirements, SANYO DENKI has developed and launched the Splash Proof Blower *San Ace 97W 9W1B* type, which has high cooling performance in the high static pressure range (hereinafter “new model”).

This article will introduce the features and performance of the new model.

## 2. Product Features

Figure 1 shows the appearance of the new model.

The new model is our first blower with IP68-rated dust- and waterproof performance.

Furthermore, it has high static pressure performance compared to an axial flow fan of equivalent size.

The features of the new model are:

- (1) High static pressure
- (2) Low power consumption and low SPL
- (3) IP68<sup>(1)</sup> dust- and waterproof performance.

(1)Protection rating

The degree of protection (IP code) is defined by IEC (International Electrotechnical Commission) 60529 “DEGREES OF PROTECTION PROVIDED BY ENCLOSURES (IP Code).” (IEC 60529:2001)



Fig. 1 *San Ace 97W 9W1B Type*

## 3. Product Overview

### 3.1 Dimensions

Figure 2 shows the dimensions of the new model.

To maintain compatibility with existing products, the new model has the same width and height dimensions as current models.

### 3.2 Specifications

Tables 1 shows the general specifications for the new model.

There are two rated voltages to choose from 12 V, 24 V, and each of these are available with speeds of 4,800 min<sup>-1</sup> (H speed), or 4,100 min<sup>-1</sup> (M speed). Figure 3 shows the airflow vs. static pressure characteristics of H speed, while Figure 4 shows the airflow vs. static pressure characteristics of M speed. The airflow vs. static pressure characteristics differ for the two speeds, and they can be selected to suit the heat generation situation of equipment. Moreover, because the product is equipped with a PWM control function to control fan speed to suit the situation, equipment power consumption and noise levels can be decreased.

The new model has an expected life of 40,000 hours at 60°C (survival rate of 90%, run continuously at rated voltage and normal humidity in free air).

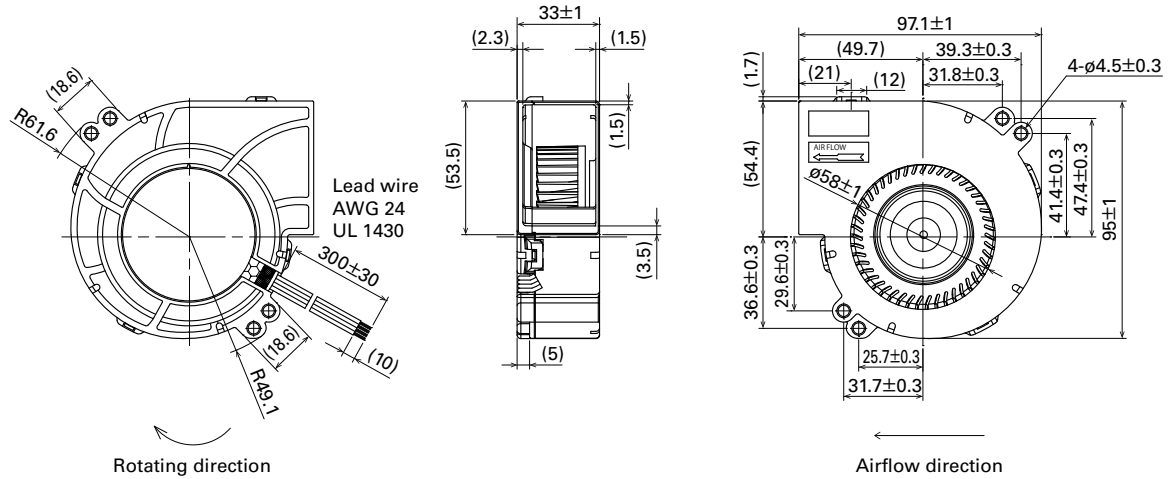

Fig. 2 Dimensions of the new model (unit: mm)

Table 1 General specifications for the new model

Model	Rated voltage [V]	Operating voltage range [V]	PWM duty cycle* [%]	Rated current [A]	Rated input [W]	Rated speed [min <sup>-1</sup> ]	Max. airflow		Max. static pressure		SPL [dB(A)]	Operating temperature range [°C]	Expected life [h]		
							[m <sup>3</sup> /min]	[CFM]	[Pa]	[inchH <sub>2</sub> O]					
9W1BM12P2H001	12	10.2 to 13.8	100	1.30	15.6	4,800	1.09	38.5	540	2.17	58	-20 to +70	40,000 at 60°C (70,000 at 40°C)		
9W1BM12P2M001			20	0.14	1.68	1,500	0.32	11.3	51	0.20	30				
9W1BM24P2H001			100	0.90	10.8	4,100	0.93	32.8	380	1.53	55				
			20	0.14	1.68	1,500	0.32	11.3	51	0.20	30				
9W1BM24P2M001	24	20.4 to 27.6	100	0.65	15.6	4,800	1.09	38.5	540	2.17	58			-20 to +70	40,000 at 60°C (70,000 at 40°C)
			20	0.07	1.68	1,500	0.32	11.3	51	0.20	30				
9W1BM24P2M001	100	0.45	10.8	4,100	0.93	32.8	380	1.53	55						
	20	0.07	1.68	1,500	0.32	11.3	51	0.20	30						

\* Input PWM frequency: 25 kHz. speed is 0 min<sup>-1</sup> at 0% PWM duty cycle.

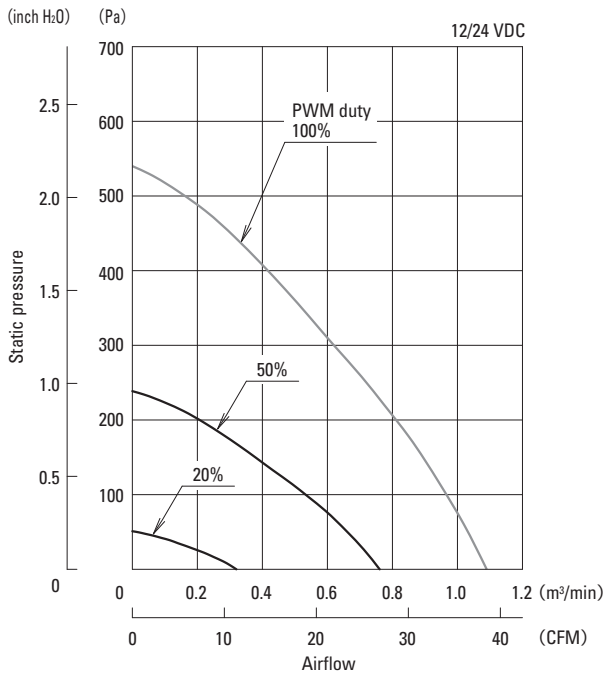

Fig. 3 Example of airflow vs. static pressure characteristics of the new model (H speed)

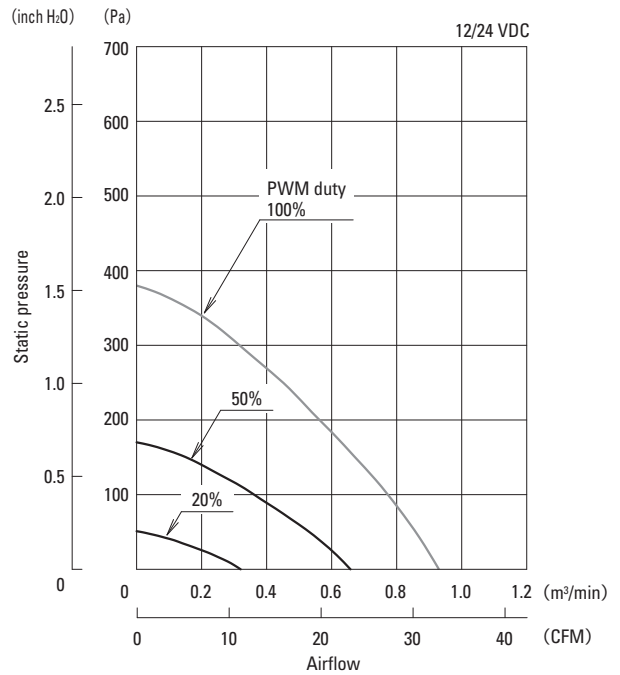

Fig. 4 Example of airflow vs. static pressure characteristics of the new model (M speed)

## 4. Key Points of Development

The new model is waterproof and supports high static pressure. Below is a brief introduction of design points.

### 4.1 Waterproof design

As Figure 5 shows, to prevent breakdown due to water penetration, live parts (motor, control circuit) are coated with resin to achieve IP68-rated dustproof and waterproof performance. Also, the following techniques were adopted so the product can be used for prolonged periods in environments exposed to water.

- (1) Magnet with excellent waterproof performance used
- (2) Coated aluminum die cast frame



Fig. 5 Appearance of the live parts of the new model

### 4.2 Frame design

The blower is made of a case consisting of a frame and cover that encloses the impeller. It was assumed that water would accumulate inside the case depending on the mounting direction of the blower and the necessary characteristics could not be achieved. For this reason, we added water drain holes to drain water from inside the case as shown in Figure 6. By taking an innovative approach to the hole shape and position, we successfully achieved both reliability and high static pressure.

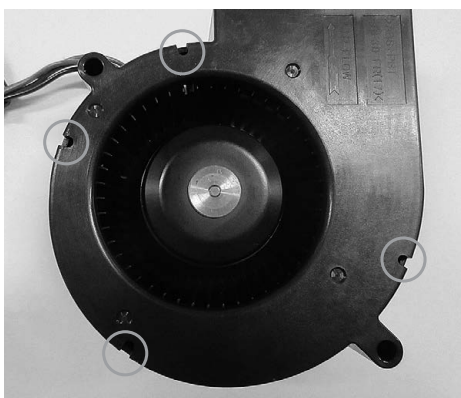

Fig. 6 Appearance of the live parts of the case

### 4.3 Impeller design

During operation, we assumed that water splashing on the impeller would cause overload, so there was a need to improve impeller strength. Based on previously accumulated reliability data, we used pressure simulation technology and increased the number and thickness of the impeller blades. We also used fluid simulation technology as shown in Figure 7 to optimize blade length and angle, and reach target performance.

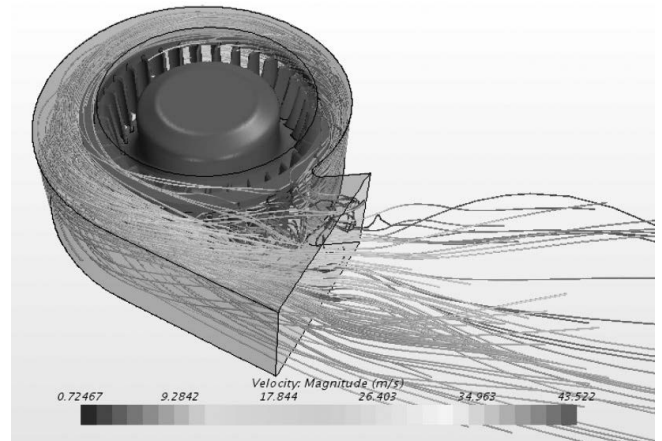

Fig. 7 Visualization of air flow

### 4.4 Circuit design

In addition to the configuration-based protection described in 4.2 and 4.3, this product is equipped with a dual protection function that suppresses motor drive current when overload is detected in the circuit.

## 5. Comparison with Splash Proof Axial Flow Fan

### 5.1 Comparison of airflow vs. static pressure characteristics

Figure 8 is a comparison of the airflow vs. static pressure characteristics for the new model 9W1BM24P2H001, and a conventional similar size model, 92 × 92 × 38 mm Splash Proof axial flow fan 9WV0924P1H001 (hereinafter “current model”). Compared to axial flow fans, blowers have higher static pressure, and the maximum static pressure of the new model is 40% higher than the current model. As such, this model can support equipment with high impedance.

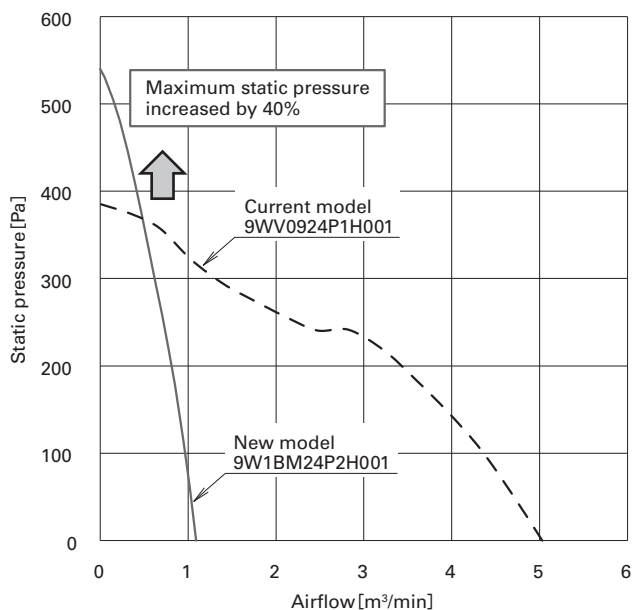

Fig. 8 Comparison of airflow vs. static pressure characteristics

## 5.2 Comparison at estimated operating point

In devices with the estimated system impedance stated in Figure 9, we compared the new and current models at the operating point where an equivalent cooling performance can be obtained. Power consumption is reduced by 74%.

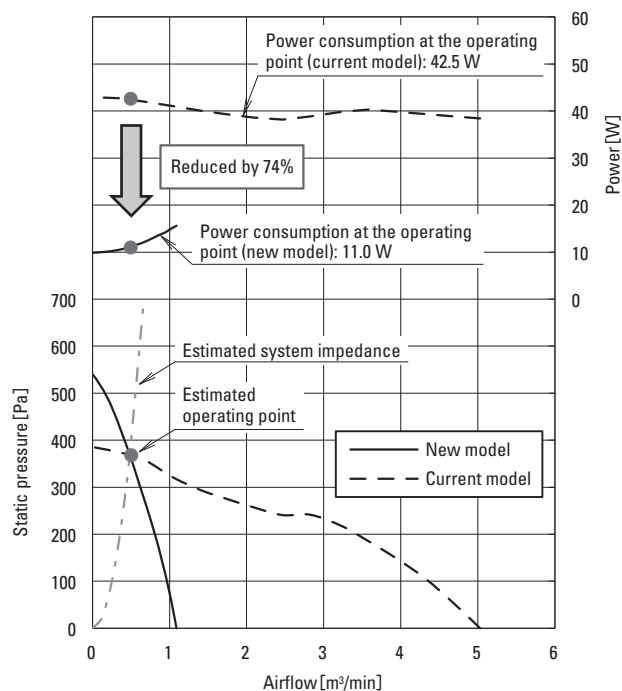

Fig. 9 Comparison of power consumption at operating point

Also, as shown in Figure 10, SPL is reduced by 13 dB(A). As described above, compared to the axial flow fan, the blower has lower power consumption and SPL in an operating range with high system impedance.

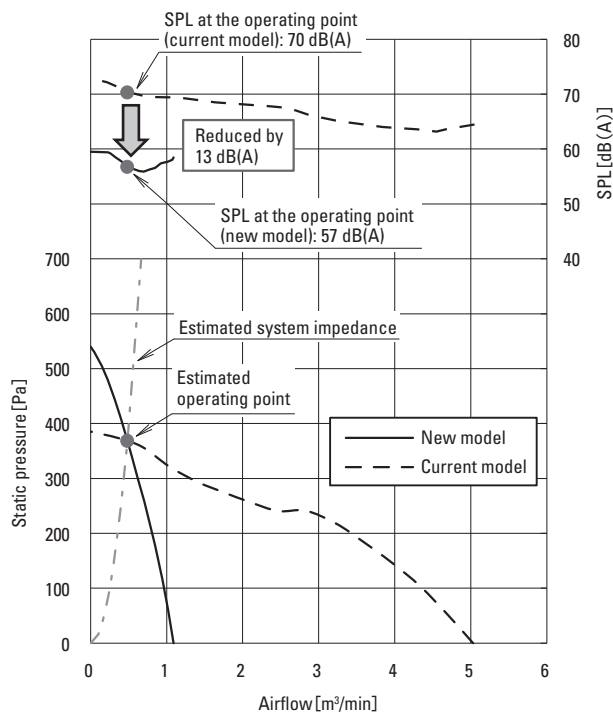

Fig. 10 Comparison of SPL at operating point

## 6. Conclusion

This article has introduced some of the features and performance of the 97 × 33 mm Splash Proof Blower *San Ace 97W 9W1B* type.

It is SANYO DENKI's first blower with high static pressure performance with an IP68 rating. As such, the new model is expected to perform well in equipment with high system impedance used in environments exposed to water and dust.

By staying ahead of the diversifying market and developing products that meet new demands, we will continue to offer products which contribute to the creation of new value for our customers to help make their dreams come true.

Authors

**Koji Ono**

Cooling Systems Div., Design Dept.  
Works on the development and design of cooling fans.

**Toshiya Nishizawa**

Cooling Systems Div., Design Dept.  
Works on the development and design of cooling fans.

**Kakuhiko Hata**

Cooling Systems Div., Design Dept.  
Works on the development and design of cooling fans.

**Takahisa Toda**

Cooling Systems Div., Design Dept.  
Works on the development and design of cooling fans.

**Masaki Kodama**

Cooling Systems Div., Design Dept.  
Works on the development and design of cooling fans.

**Hikomitsu Kuribayashi**

Cooling Systems Div., Design Dept.  
Works on the development and design of cooling fans.